



CÁMARAS FRIGORÍFICAS

ARMARIOS DESMONTABLES REFRIGERACIÓN Y CONGELACIÓN	pg. 397
<hr/>	
CÁMARAS FRIGORÍFICAS PANELABLES MINICÁMARAS	pg. 398
<hr/>	
CÁMARAS FRIGORÍFICAS PANELABLES SUPEREKO	pg. 400
<hr/>	
CÁMARAS FRIGORÍFICAS PANELABLES SUPEREKO 70 mm.	pg. 402
<hr/>	
CÁMARAS FRIGORÍFICAS PANELABLES SUPEREKO 100 mm.	pg. 408
<hr/>	
CÁMARAS FRIGORÍFICAS MONOBLOCKS	pg. 413
<hr/>	
CÁMARAS FRIGORÍFICAS MONOBLOCKS ALTA TEMPERATURA	pg. 414
<hr/>	
CÁMARAS FRIGORÍFICAS MONOBLOCKS BAJA TEMPERATURA	pg. 416
<hr/>	
CÁMARAS FRIGORÍFICAS MONOBLOCKS	pg. 418
<hr/>	
ESTANTERÍAS LINEALES EN ALUMINIO Y POLIPROPILENO	pg. 419
<hr/>	
ESTANTERÍAS: ACCESORIOS	pg. 420
<hr/>	
ESTANTERÍAS CON ESTRUCTURA EN ALUMINIO Y PARRILLAS EN POLIPROPILENO	pg. 421



ARMARIOS DESMONTABLES REFRIGERACIÓN Y CONGELACIÓN

TECNODOM spa
refrigerazione



CAMARAS FRIGORIFICAS



CÓDIGO	CAPACIDAD (litros)	MEDIDA PANEL (mm)	TEMP. TRABAJO (°C)	POTENCIA ABS. (W)	PRECIO €
MASTERCOOL SP 60 TN	1220	60	0/+8	510	2.639
MASTERCOOL SP 60 BT	1220	60	-18/-20	1230	3.278

PORTES PAGADOS

MASTERCOOL SP 60 TN  2120
MASTERCOOL SP 60 BT 1000

características

- Paneles verticales y techo interno con revestimiento de acero zincado plastificado atóxico de color blanco.
- Armario completamente desmontable, monoblock ya instalado en el panel del techo.
- Suelo interno en acero inoxidable.
- Luz de paso de puerta 700x1680 mm.
- Puerta con autocierre.
- Desescarche automático del agua de condensación.
- 3 estantes incluidos en el precio.
- Panel de control electrónico con sonda NTC.
- Refrigeración ventilada.
- Grupo tropicalizado de serie a 43°C con una humedad relativa del 65%.
- Tensión: 230V/50Hz.



CÁMARAS FRIGORÍFICAS PANELABLES MINI CÁMARAS



TECNODOM spa
refrigerazione

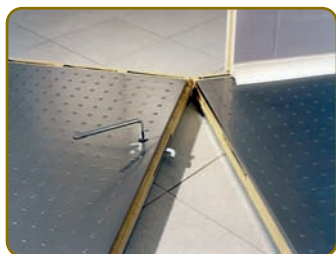

DETALLE SUELO INOX.

características

- Paneles verticales y techo interno con revestimiento de acero zincado plastificado atóxico de color blanco.
- Suelo interno en acero antideslizamiento.
- Ángulos internos redondeados.
- **Apertura de la puerta estándar: de izquierda a derecha. Bajo pedido se puede colocar con la apertura al lado contrario, es decir, de derecha a izquierda.**
- Aislamiento realizado con inyección de poliuretano expandido sin CFC's ni HCFC's, con una densidad de 40-42kg/m³.
- La unión de los paneles queda garantizada por un sistema de ganchos excéntricos que permite un rápido y eficaz bloqueo de los elementos, operando desde la parte interna de la cámara.
- Puerta de acceso dotada de cerradura con llave y desbloqueo interno de seguridad. Medida de 1750 (h) x 630 mm. (luz interior/paso de luz).
- Las cámaras de baja temperatura llevan una resistencia anticondensación en el perfil perimetral del hueco de la puerta y válvula de compensación.
- **Se pueden suministrar con el interior de la cámara en acero inox. (preguntar precios y plazos de entrega).**





CÁMARAS FRIGORÍFICAS PANELABLES MINI CÁMARAS



CÓDIGO	MEDIDA PANEL (mm)	MEDIDAS EXTERIORES (mm)			VOLUMEN (m³)	PRECIO € REFRIGERACIÓN	PRECIO € CONGELACIÓN
		ancho	fondo	alto			
MC 1010	80	1000	1000	2060	1,34	1.528,89	1.655,56
MC 1012	80	1000	1200	2060	1,66	1.666,67	1.793,33
MC 1212	80	1200	1200	2060	2,06	1.813,33	1.940,00
MC 1214	80	1200	1400	2060	2,45	1.964,44	2.091,11
MC 1216	80	1200	1600	2060	2,85	2.111,11	2.237,78
MC 1218	80	1200	1800	2060	3,24	2.257,78	2.384,44
MC 1220	80	1200	2000	2060	3,64	2.408,89	2.535,56
MC 1414	80	1400	1400	2060	2,92	2.120,00	2.246,67
MC 1416	80	1400	1600	2060	3,39	2.278,89	2.405,56
MC 1418	80	1400	1800	2060	3,86	2.438,89	2.565,56
MC 1420	80	1400	2000	2060	4,34	2.594,44	2.721,11
MC 1616	80	1600	1600	2060	3,94	2.447,78	2.574,44
MC 1618	80	1600	1800	2060	4,49	2.615,56	2.742,22
MC 1620	80	1600	2000	2060	5,03	2.783,33	2.910,00
MC 1622	80	1600	2200	2060	5,58	2.952,22	3.078,89
MC 1624	80	1600	2400	2060	6,13	3.120,00	3.246,67
MC 1818	80	1800	1800	2060	5,11	2.793,33	2.920,00
MC 1820	80	1800	2000	2060	5,73	2.970,00	3.096,67
MC 1822	80	1800	2200	2060	6,36	3.146,67	3.273,33
MC 1824	80	1800	2400	2060	6,98	3.327,78	3.454,44
MC 2020	80	2000	2000	2060	6,43	3.158,89	3.285,56
MC 2022	80	2000	2200	2060	7,13	3.345,56	3.472,22
MC 2024	80	2000	2400	2060	7,83	3.534,44	3.661,11
MC 2220	80	2200	2200	2060	7,91	3.543,33	3.670,00
MC 2224	80	2200	2400	2060	8,68	3.742,22	3.868,89
MC 2424	80	2400	2400	2060	9,53	3.948,89	4.075,56

PORTES PAGADOS

CÁMARAS FRIGORÍFICAS PANELABLES SUPEREKO



DETALLE MONTAJE SUELO CON PARED

características

- Las cámaras SUPEREKO están proyectadas para satisfacer cualquier tipo de exigencia de la conservación moderna.
- La elevada calidad de las cámaras SUPEREKO y el proceso productivo permiten respetar las normas higiénico-sanitarias más restrictivas, a la vez que una elevada flexibilidad y rapidez de montaje.
- Las cámaras SUPEREKO están compuestas por paneles modulares de largura variable y espesores de 70 y 100 mm.
- El aislamiento está realizado con inyección de poliuretano expandido rígido de densidad 40-42 kg³.
- La unión de los paneles queda garantizada por un sistema de ganchos excéntricos que permite un rápido y eficaz bloqueo de los elementos, operando desde la parte interna de la cámara.
- El revestimiento interno de las paredes está constituido por láminas de acero zincado prelacado atóxico, mientras que el suelo es de acero inoxidable AISI 304 antideslizante con un adecuado soporte interno para una mejor distribución de la carga.
- Soporta cargas de hasta 400 kg/m² uniformemente distribuidas.
- Bajo pedido se pueden solicitar con las paredes revestidas en acero inoxidable AISI 304 y suelos reforzados para mayores cargas.
- Las cámaras son dimensionalmente estables y no se degradan con el tiempo.
- Los materiales que la componen están estudiados para no absorber los olores, no permitir los parásitos y no favorecer el desarrollo de hongos ni musgo.
- Las cámaras pueden ser desmontadas, ampliadas o reducidas, y recolocadas en otro lugar sin deterioro de sus componentes.
- Perfil sanitario incluido.
- Los modelos BT incluyen: resistencia anticondensación en el perfil de la puerta y válvula de compensación.
- Para otras medidas intermedias de ancho y alto (consultar precios y plazos de entrega)



CÁMARAS FRIGORÍFICAS PANELABLES SUPEREKO

TECNODOM spa
refrigerazione

CAMARAS FRIGORIFICAS

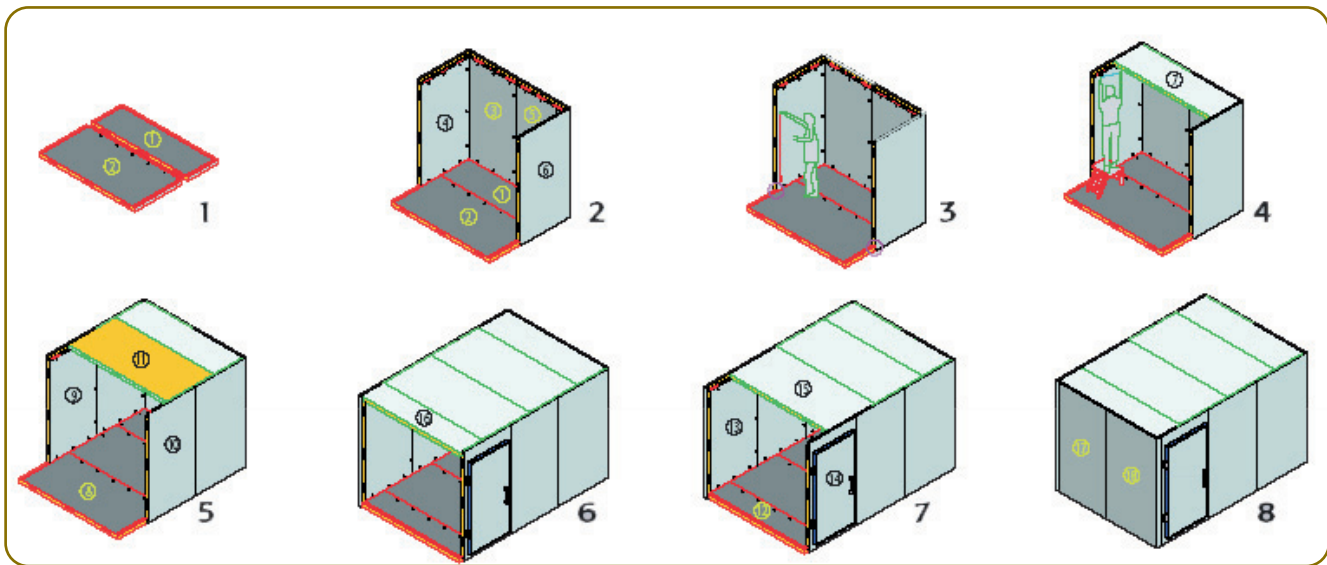

ORDEN DE MONTAJE

aislamiento

DESCRIPCIÓN

COEFICIENTE DE CONDUCTIVIDAD TÉRMICA	0,018 Kcal/h m °C
COEFICIENTE DE TRANSMISIÓN K (panel de 70 mm.)	0,26 Kcal/h m ² °C
COEFICIENTE DE TRANSMISIÓN K (panel de 100 mm.)	0,18 Kcal/h m ² °C
COMPORTAMIENTO AL FUEGO	ISO 3582
RESISTENCIA A LA COMPRESIÓN	1,5±2 Kg/cm ²
CAMPO DE APLICACIÓN	-60/+80°C
PERMEABILIDAD. Prueba con vapor de agua 30-60 gr./m ³ durante 24 h. a 23°C y 85% de humedad en exterior.	0



CÁMARAS PANELABLES SUPEREKO (70 mm) REFRIGERACIÓN



DIMENSIONES EXT. (mm)	ALTURA 2140 (m³)		EQUIPO MONOBLOCK MOCHILA TECHO		ALTURA 2540 (m³)		EQUIPO MONOBLOCK MOCHILA TECHO		ALTURA 2940 (m³)		EQUIPO MONOBLOCK MOCHILA TECHO	
	PVP				PVP				PVP			
1140X1140	2,00	1.873,55	KBA-8-TNEM	KBS-08-TNEM	2,40	2.107,23	KBA-8-TNEM	KBS-08-TNEM	2,80	2.382,88	KBA-8-TNEM	KBS-08-TNEM
1140X1340	2,40	2.062,56	KBA-8-TNEM	KBS-8-TNEM	2,88	2.316,52	KBA-8-TNEM	KBS-8-TNEM	3,36	2.613,84	KBA-8-TNEM	KBS-8-TNEM
1140X2140	4,00	2.818,57	KBA-8-TNEM	KBS-11-TNEM	4,80	3.153,68	KBA-11-TNEM	KBS-11-TNEM	5,60	3.542,62	KBA-11-TNEM	KBS-11-TNEM
1140X2940	5,60	3.574,59	KBA-11-TNEM	KBS-13-TNEM	6,72	3.989,60	KBA-11-TNEM	KBS-13-TNEM	7,84	4.470,13	KBA-13-TNEM	KBS-13-TNEM
1140X3740	7,20	4.329,38	KBA-13-TNEM	KBS-13-TNEM	8,64	4.826,72	KBA-13-TNEM	KBS-13-TNEM	10,08	5.397,68	KBA-13-TNEM	KBS-13-TNEM
1140X4540	8,80	5.085,40	KBA-13-TNEM	KBS-13-TNEM	10,56	5.662,65	KBA-17-TNEM	KBS-17-TNEM	12,32	6.325,18	KBA-17-TNEM	KBS-17-TNEM
1140X5340	10,40	5.841,41	KBA-13-TNEM	KBS-13-TNEM	12,48	6.498,57	KBA-17-TNEM	KBS-17-TNEM	14,56	7.252,69	KBA-17-TNEM	KBS-20-TNEM
1340X1340	2,88	2.136,97	KBA-8-TNEM	KBS-08-TNEM	3,46	2.396,31	KBA-8-TNEM	KBS-08-TNEM	4,03	2.857,49	KBA-8-TNEM	KBS-11-TNEM
1340X1540	3,36	2.325,98	KBA-8-TNEM	KBS-8-TNEM	4,03	2.604,79	KBA-8-TNEM	KBS-11-TNEM	4,70	3.101,14	KBA-8-TNEM	KBS-11-TNEM
1340X2340	5,28	3.080,83	KBA-11-TNEM	KBS-11-TNEM	6,34	3.437,51	KBA-11-TNEM	KBS-13-TNEM	7,39	4.074,47	KBA-11-TNEM	KBS-13-TNEM
1340X3140	7,20	3.836,85	KBA-11-TNEM	KBS-13-TNEM	8,64	4.270,26	KBA-13-TNEM	KBS-13-TNEM	10,08	5.047,80	KBA-13-TNEM	KBS-13-TNEM
1340X3940	9,12	4.592,86	KBA-13-TNEM	KBS-13-TNEM	10,94	5.104,18	KBA-13-TNEM	KBS-17-TNEM	12,77	6.021,16	KBA-17-TNEM	KBS-17-TNEM
1340X4740	11,04	5.347,72	KBA-17-TNEM	KBS-17-TNEM	13,25	5.936,90	KBA-17-TNEM	KBS-17-TNEM	15,46	6.994,49	KBA-17-TNEM	KBS-20-TNEM
1340X5340	12,46	5.914,73	KBA-17-TNEM	KBS-17-TNEM	14,98	6.562,34	KBA-17-TNEM	KBS-20-TNEM	17,47	7.724,21	KBA-20-TNEM	KBS-20-TNEM
1540X1540	3,92	2.525,48	KBA-8-TNEM	KBS-11-TNEM	4,70	2.824,09	KBA-8-TNEM	KBS-11-TNEM	5,49	3.356,25	KBA-11-TNEM	KBS-11-TNEM
1540X1740	4,48	2.724,99	KBA-8-TNEM	KBS-11-TNEM	5,38	3.042,22	KBA-11-TNEM	KBS-11-TNEM	6,27	3.610,08	KBA-11-TNEM	KBS-13-TNEM
1540X2540	6,72	3.521,84	KBA-11-TNEM	KBS-13-TNEM	8,06	3.919,37	KBA-13-TNEM	KBS-13-TNEM	9,41	4.629,26	KBA-13-TNEM	KBS-13-TNEM
1540X3340	8,96	4.318,69	KBA-13-TNEM	KBS-13-TNEM	10,75	4.795,37	KBA-13-TNEM	KBS-17-TNEM	12,54	5.648,41	KBA-17-TNEM	KBS-17-TNEM
1540X4140	11,20	5.116,71	KBA-17-TNEM	KBS-17-TNEM	13,44	5.671,39	KBA-13-TNEM	KBS-17-TNEM	15,68	6.667,56	KBA-20-TNEM	KBS-20-TNEM
1540X4940	13,44	5.913,56	KBA-17-TNEM	KBS-17-TNEM	16,13	6.547,38	KBA-25-TNEM	KBS-20-TNEM	18,82	7.686,71	KBA-25-TNEM	KBS-25-TNEM
1540X5340	14,56	6.312,57	KBA-20-TNEM	KBS-20-TNEM	17,47	6.985,98	KBA-25-TNEM	KBS-25-TNEM	20,38	8.195,68	KBA-25-TNEM	KBS-25-TNEM
1740X1740	5,12	2.933,82	KBA-11-TNEM	KBS-11-TNEM	6,14	3.272,30	KBA-11-TNEM	KBS-11-TNEM	7,17	3.876,64	KBA-11-TNEM	KBS-13-TNEM
1740X1940	5,76	3.143,83	KBA-11-TNEM	KBS-11-TNEM	6,91	3.502,41	KBA-11-TNEM	KBS-13-TNEM	8,06	4.143,20	KBA-13-TNEM	KBS-13-TNEM
1740X2740	8,32	3.982,68	KBA-13-TNEM	KBS-13-TNEM	9,98	4.421,68	KBA-13-TNEM	KBS-13-TNEM	11,65	5.206,93	KBA-17-TNEM	KBS-17-TNEM
1740X3540	10,88	4.822,70	KBA-13-TNEM	KBS-17-TNEM	13,06	5.340,98	KBA-17-TNEM	KBS-17-TNEM	15,23	6.271,90	KBA-20-TNEM	KBS-20-TNEM
1740X3434	13,44	5.661,55	KBA-17-TNEM	KBS-17-TNEM	16,13	6.260,24	KBA-20-TNEM	KBS-20-TNEM	18,82	7.336,87	KBA-25-TNEM	KBS-25-TNEM
1740X5140	16,00	6.500,40	KBA-20-TNEM	KBS-20-TNEM	19,20	7.179,50	KBA-25-TNEM	KBS-25-TNEM	22,40	8.400,60	KBA-32-TNEM	KBS-32-TNEM
1740X5340	16,64	6.710,40	KBA-25-TNEM	KBS-20-TNEM	19,97	7.409,62	KBA-25-TNEM	KBS-25-TNEM	23,30	8.667,16	KBA-32-TNEM	KBS-32-TNEM

PORTES PAGADOS





CÁMARAS PANELABLES SUPEREKO (70 mm) REFRIGERACIÓN



DIMENSIONES EXT. (mm)	ALTURA 2140		EQUIPO MONOBLOCK		ALTURA 2540		EQUIPO MONOBLOCK		ALTURA 2940		EQUIPO MONOBLOCK	
	(m³)	PVP	MOCHILA	TECHO	(m³)	PVP	MOCHILA	TECHO	(m³)	PVP	MOCHILA	TECHO
1940X1940	6,48	3.364,33	KBA-11-TNEM	KBS-13-TNEM,	7,78	3.743,35	KBA-13-TNEM	KBS-13-TNEM	9,07	4.419,98	KBA-13-TNEM	KBS-13-TNEM
1940X2140	7,20	3.584,84	KBA-11-TNEM	KBS-13-TNEM	8,64	3.983,12	KBA-13-TNEM	KBS-13-TNEM	10,08	4.697,96	KBA-13-TNEM	KBS-13-TNEM
1940X2940	10,08	4.465,69	KBA-13-TNEM	KBS-13-TNEM	12,10	4.945,65	KBA-17-TNEM	KBS-17-TNEM	14,11	5.807,51	KBA-17-TNEM	KBS-20-TNEM
1940X3740	12,96	5.346,54	KBA-17-TNEM	KBS-17-TNEM	15,55	5.908,19	KBA-20-TNEM	KBS-20-TNEM	18,14	6.918,30	KBA-25-TNEM	KBS-25-TNEM
1940X4540	15,84	6.227,39	KBA-20-TNEM	KBS-20-TNEM	19,01	6.870,72	KBA-25-TNEM	KBS-25-TNEM	22,18	8.027,85	KBA-32-TNEM	KBS-32-TNEM
1940X5340	18,72	7.108,24	KBA-25-TNEM	KBS-25-TNEM	22,46	7.833,26	KBA-32-TNEM	KBS-32-TNEM	26,21	9.138,64	KBA-32-TNEM	KBS-32-TNEM
2140X2140	8,00	3.814,68	KBA-13-TNEM	KBS-11-TNEM	9,60	4.234,83	KBA-13-TNEM	KBS-13-TNEM	11,20	4.986,19	KBA-17-TNEM	KBS-17-TNEM
2140X2340	8,80	4.045,68	KBA-13-TNEM	KBS-13-TNEM	10,56	4.486,59	KBA-13-TNEM	KBS-17-TNEM	12,32	5.275,66	KBA-17-TNEM	KBS-17-TNEM
2140X3140	12,00	4.968,53	KBA-17-TNEM	KBS-17-TNEM	14,40	5.491,23	KBA-17-TNEM	KBS-20-TNEM	16,80	6.431,00	KBA-20-TNEM	KBS-20-TNEM
2140X3940	15,20	5.891,38	KBA-20-TNEM	KBS-20-TNEM	18,24	6.497,03	KBA-25-TNEM	KBS-25-TNEM	21,28	7.587,60	KBA-32-TNEM	KBS-32-TNEM
2140X4710	18,40	6.813,18	KBA-25-TNEM	KBS-25-TNEM	22,08	7.502,84	KBA-32-TNEM	KBS-32-TNEM	25,76	8.742,98	KBA-32-TNEM	KBS-32-TNEM
2140X5340	20,80	7.506,08	KBA-32-TNEM	KBS-25-TNEM	24,96	8.256,90	KBA-32-TNEM	KBS-32-TNEM	29,12	9.610,11	KBA-32-TNEM	KBS-35-TNET
2340X2340	9,68	4.287,18	KBA-13-TNEM	KBS-13-TNEM	11,62	4.747,99	KBA-17-TNEM	KBS-17-TNEM	13,55	5.576,55	KBA-17-TNEM	KBS-17-TNEM
2340X2540	10,56	4.528,69	KBA-13-TNEM	KBS-17-TNEM	12,67	5.010,56	KBA-17-TNEM	KBS-17-TNEM	14,78	5.876,24	KBA-17-TNEM	KBS-20-TNEM
2340X3340	14,08	5.492,37	KBA-17-TNEM	KBS-20-TNEM	16,90	6.058,44	KBA-25-TNEM	KBS-20-TNEM	19,71	7.077,39	KBA-25-TNEM	KBS-25-TNEM
2340X4140	17,60	6.457,22	KBA-25-TNEM	KBS-25-TNEM	21,12	7.107,52	KBA-32-TNEM	KBS-32-TNEM	24,64	8.278,58	KBA-32-TNEM	KBS-32-TNEM
2340X4940	21,12	7.422,08	KBA-32-TNEM	KBS-32-TNEM	25,34	8.155,43	KBA-32-TNEM	KBS-32-TNEM	29,57	9.480,97	KBA-32-TNEM	KBS-35-TNET
2340X5340	22,88	7.903,92	KBA-32-TNEM	KBS-32-TNEM	27,46	8.680,54	KBA-32-TNEM	KBS-32-TNEM	32,03	10.081,59	KBA-35-TNEM	KBS-35-TNET
2540X2540	11,52	4.699,33	KBA-17-TNEM	KBS-17-TNEM	13,82	5.282,75	KBA-17-TNEM	KBS-17-TNEM	16,13	6.188,58	KBA-20-TNEM	KBS-20-TNEM
2540X3540	16,32	6.038,38	KBA-25-TNEM	KBS-20-TNEM	19,58	6.647,32	KBA-25-TNEM	KBS-25-TNEM	22,85	7.746,70	KBA-32-TNEM	KBS-32-TNEM
2540X4540	21,12	7.296,07	KBA-32-TNEM	KBS-25-TNEM	25,34	8.011,86	KBA-32-TNEM	KBS-32-TNEM	29,57	9.306,05	KBA-32-TNEM	KBS-35-TNET
2540X5740	26,88	8.805,76	KBA-32-TNEM	KBS-32-TNEM	32,26	9.649,78	KBA-35-TNEM	KBS-35-TNET	37,63	11.176,55	KBA-35-TNEM	KBS-35-TNET
2540X6740	31,68	10.063,45	KBA-35-TNEM	KBS-35-TNET	38,02	11.014,32	KBA-35-TNEM	KBS-35-TNET	44,35	12.734,67	KBA-40-TNET	KBS-40-TNET
2540X7740	36,48	11.322,31	KBA-35-TNEM	KBS-35-TNET	43,78	12.378,89	KBA-40-TNET	KBS-40-TNET	51,07	14.294,03	KBA-40-TNET	KBS-40-TNET

PORTES PAGADOS



PORTES PAGADOS

CÁMARAS PANELABLES SUPEREKO (70 mm) REFRIGERACIÓN



DIMENSIONES EXT. (mm)	ALTURA 2140		EQUIPO MONOBLOCK		ALTURA 2540		EQUIPO MONOBLOCK		ALTURA 2940		EQUIPO MONOBLOCK	
	(m³)	PVP	MOCHILA	TECHO	(m³)	PVP	MOCHILA	TECHO	(m³)	PVP	MOCHILA	TECHO
2740X2740	13,52	5.294,04	KBA-17-TNEM	KBS-20-TNEM	16,22	5.840,34	KBA-20-TNEM	KBS-20-TNEM	18,93	6.823,56	KBA-25-TNEM	KBS-25-TNEM
2740X3740	18,72	6.604,22	KBA-25-TNEM	KBS-25-TNEM	22,46	7.257,80	KBA-32-TNEM	KBS-32-TNEM	26,21	8.438,92	KBA-32-TNEM	KBS-32-TNEM
2740X4740	23,92	7.914,41	KBA-32-TNEM	KBS-32-TNEM	28,70	8.676,43	KBA-32-TNEM	KBS-32-TNEM	33,49	10.054,31	KBA-35-TNEM	KBS-35-TNET
2740X5740	29,12	9.224,60	KBA-32-TNEM	KBS-32-TNEM	34,94	10.095,06	KBA-35-TNEM	KBS-35-TNET	40,77	11.670,94	KBA-35-TNEM	KBS-35-TNET
2740X6740	34,32	10.534,79	KBA-35-TNEM	KBS-35-TNET	41,18	11.512,52	KBA-35-TNEM	KBS-40-TNET	48,05	13.286,30	KBA-40-TNET	KBS-40-TNET
2740X7740	39,52	11.844,98	KBA-35-TNEM	KBS-35-TNET	47,42	12.931,15	KBA-40-TNET	KBS-40-TNET	55,33	14.901,69	KBA-40-TNET	KBS-40-TNET
2940X2940	15,68	5.828,38	KBA-20-TNEM	KBS-25-TNEM	18,82	6.418,37	KBA-25-TNEM	KBS-25-TNEM	21,95	7.480,18	KBA-32-TNEM	KBS-32-TNEM
2940X3940	21,28	7.191,07	KBA-32-TNEM	KBS-32-TNEM	25,54	7.889,92	KBA-32-TNEM	KBS-32-TNEM	29,79	9.154,04	KBA-32-TNEM	KBS-35-TNET
2940X4940	26,88	8.553,76	KBA-32-TNEM	KBS-32-TNEM	32,26	9.362,64	KBA-35-TNEM	KBS-35-TNET	37,63	10.826,71	KBA-35-TNEM	KBS-35-TNET
2940X6140	33,60	10.188,28	KBA-35-TNEM	KBS-35-TNET	40,32	11.129,18	KBA-35-TNEM	KBS-35-TNET	47,04	12.833,40	KBA-40-TNET	KBS-40-TNET
2940X7140	39,20	11.550,97	KBA-35-TNEM	KBS-35-TNET	47,04	12.600,73	KBA-40-TNET	KBS-40-TNET	54,88	14.506,03	KBA-40-TNET	KBS-40-TNET
2940X7740	42,56	12.124,71	KBA-40-TNET	KBS-40-TNET	51,07	13.484,60	KBA-40-TNET	KBS-40-TNET	59,58	15.510,63	KBA-40-TNET	-
3140X3140	18,00	6.383,72	KBA-25-TNEM	KBS-25-TNEM	21,60	7.018,03	KBA-32-TNEM	KBS-32-TNEM	25,20	8.160,94	KBA-32-TNEM	KBS-32-TNEM
3140X4140	24,00	7.798,91	KBA-32-TNEM	KBS-32-TNEM	28,80	8.543,68	KBA-32-TNEM	KBS-32-TNEM	33,60	9.890,85	KBA-35-TNEM	KBS-35-TNET
3140X5140	30,00	9.212,93	KBA-32-TNEM	KBS-35-TNET	36,00	10.069,28	KBA-35-TNEM	KBS-35-TNET	42,00	11.620,75	KBA-35-TNEM	KBS-40-TNET
3140X6140	36,00	10.628,12	KBA-35-TNEM	KBS-35-TNET	43,20	11.596,09	KBA-40-TNET	KBS-40-TNET	50,40	13.350,70	KBA-40-TNET	KBS-40-TNET
3140X7140	42,00	12.043,31	KBA-35-TNEM	KBS-40-TNET	50,40	13.121,73	KBA-40-TNET	KBS-40-TNET	58,80	15.080,60	KBA-40-TNET	-
3140X7740	45,60	12.891,49	KBA-40-TNET	KBS-40-TNET	54,72	14.036,86	KBA-40-TNET	KBS-40-TNET	63,84	16.118,29	KBA-40-TNET	-
3340X3340	20,48	6.960,06	KBA-25-TNEM	KBS-32-TNEM	24,58	7.639,34	KBA-32-TNEM	KBS-32-TNEM	28,67	8.864,61	KBA-32-TNEM	KBS-32-TNEM
3340X4340	26,88	8.426,58	KBA-32-TNEM	KBS-32-TNEM	32,26	9.219,03	KBA-35-TNEM	KBS-35-TNET	37,63	10.651,79	KBA-35-TNEM	KBS-35-TNET
3340X5340	33,28	9.894,27	KBA-35-TNEM	KBS-35-TNET	39,94	10.798,76	KBA-35-TNEM	KBS-35-TNET	46,59	12.437,74	KBA-40-TNET	KBS-40-TNET
3340X5340	39,68	11.361,96	KBA-35-TNEM	KBS-35-TNET	47,62	12.378,49	KBA-40-TNET	KBS-40-TNET	55,55	14.224,92	KBA-40-TNET	KBS-40-TNET
3340X7340	46,08	12.828,48	KBA-40-TNET	KBS-40-TNET	55,30	13.958,19	KBA-40-TNET	KBS-40-TNET	64,51	16.012,10	KBA-40-TNET	-

PORTES PAGADOS





CÁMARAS PANELABLES SUPEREKO (70 mm) REFRIGERACIÓN

TECNODOM
refrigerazione spa

CAMARAS FRIGORIFICAS



DIMENSIONES EXT. (mm)	ALTURA 2140		EQUIPO MONOBLOCK		ALTURA 2540		EQUIPO MONOBLOCK		ALTURA 2940		EQUIPO MONOBLOCK	
	(m³)	PVP	MOCHILA	TECHO	(m³)	PVP	MOCHILA	TECHO	(m³)	PVP	MOCHILA	TECHO
3540X3540	23,12	7.557,40	KBA-32-TNEM	KBS-32-TNEM	27,74	8.281,11	KBA-32-TNEM	KBS-32-TNEM	32,37	9.591,16	KBA-35-TNEM	KBS-35-TNET
3540X4540	29,92	9.076,43	KBA-32-TNEM	KBS-35-TNET	35,90	9.914,89	KBA-35-TNEM	KBS-35-TNET	41,89	11.434,38	KBA-35-TNEM	KBS-40-TNET
3540X5540	36,72	10.596,62	KBA-35-TNEM	KBS-35-TNET	44,06	11.548,71	KBA-40-TNET	KBS-40-TNET	51,41	13.278,83	KBA-40-TNET	KBS-40-TNET
3540X6540	43,52	12.115,64	KBA-40-TNET	KBS-40-TNET	52,22	13.182,50	KBA-40-TNET	KBS-40-TNET	60,93	15.122,05	KBA-40-TNET	-
3540X7540	50,32	13.634,66	KBA-40-TNET	KBS-40-TNET	60,38	14.816,29	KBA-40-TNET	-	70,45	16.966,51	-	-

3740X3740	25,92	8.175,75	KBA-32-TNEM	KBS-32-TNEM	31,10	8.945,68	KBA-35-TNEM	KBS-35-TNET	36,29	10.339,41	KBA-35-TNEM	KBS-35-TNET
3740X4740	33,12	9.747,27	KBA-35-TNEM	KBS-35-TNET	39,74	10.633,55	KBA-35-TNEM	KBS-35-TNET	46,37	12.241,14	KBA-40-TNET	KBS-40-TNET
3740X5740	40,32	11.318,79	KBA-35-TNEM	KBS-35-TNET	48,38	12.320,26	KBA-35-TNEM	KBS-40-TNET	56,45	14.141,60	KBA-40-TNET	-
3740X6740	47,52	12.890,31	KBA-40-TNET	KBS-40-TNET	57,02	14.008,14	KBA-40-TNET	-	66,53	16.042,10	-	-
3740X7740	54,72	14.461,84	KBA-40-TNET	KBS-40-TNET	65,66	15.696,02	-	-	76,61	17.943,83	-	-

3940X3940	28,88	8.815,09	KBA-32-TNEM	KBS-32-TNEM	34,66	9.631,89	KBA-35-TNEM	KBS-35-TNET	40,43	11.111,81	KBA-40-TNET	KBS-35-TNET
3940X4940	36,48	10.439,11	KBA-35-TNEM	KBS-35-TNET	43,78	11.372,69	KBA-40-TNET	KBS-40-TNET	51,07	13.069,55	KBA-40-TNET	KBS-40-TNET
3940X5940	44,08	12.061,97	KBA-40-TNET	KBS-40-TNET	52,90	13.114,62	KBA-40-TNET	KBS-40-TNET	61,71	15.027,32	KBA-40-TNET	-
3940X6940	51,68	13.685,99	KBA-40-TNET	KBS-40-TNET	62,02	14.855,42	KBA-40-TNET	-	72,35	16.985,05	-	-
3940X7740	57,76	14.985,67	KBA-40-TNET	KBS-40-TNET	69,31	16.248,31	-	-	80,86	18.551,49	-	-

4140X4140	32,00	9.474,26	KBA-35-TNEM	KBS-35-TNET	38,40	10.338,53	KBA-35-TNEM	KBS-35-TNET	44,80	11.905,85	KBA-40-TNET	KBS-40-TNET
4140X5140	40,00	11.150,79	KBA-35-TNEM	KBS-35-TNET	48,00	12.134,59	KBA-40-TNET	KBS-40-TNET	56,00	13.920,90	KBA-40-TNET	KBS-40-TNET
4140X6140	48,00	12.827,31	KBA-40-TNET	KBS-40-TNET	57,60	13.929,48	KBA-40-TNET	-	67,20	15.935,91	-	-
4140X7140	56,00	14.503,83	KBA-40-TNET	KBS-40-TNET	67,20	15.724,37	-	-	78,40	17.950,91	-	-
4140X7740	60,80	15.509,51	KBA-40-TNET	-	72,96	16.801,76	-	-	85,12	19.159,19	-	-

PORTES PAGADOS



CÁMARAS PANELABLES SUPEREKO (70 mm) REFRIGERACIÓN



DIMENSIONES EXT. (mm)	ALTURA 2140			EQUIPO MONOBLOCK		ALTURA 2540			EQUIPO MONOBLOCK			
	(m³)	PVP	MOCHILA	TECHO	(m³)	PVP	MOCHILA	TECHO	(m³)	PVP	MOCHILA	TECHO
4340X4340	35,28	10.155,61	KBA-35-TNEM	KBS-35-TNET	42,34	11.068,01	KBA-40-TNET	KBS-35-TNET	49,39	12.722,84	KBA-40-TNET	KBS-40-TNET
4340X5340	43,66	11.884,63	KBA-40-TNET	KBS-40-TNET	52,42	12.916,99	KBA-40-TNET	KBS-40-TNET	61,15	14.795,12	KBA-40-TNET	-
4340X6340	52,06	13.612,48	KBA-40-TNET	KBS-40-TNET	62,50	14.765,94	KBA-40-TNET	-	72,91	16.867,40	-	-
4340X7340	60,48	15.341,51	KBA-40-TNET	-	72,58	16.614,92	-	-	84,67	18.939,69	-	-
4340X7740	63,84	16.032,18	KBA-40-TNET	-	76,61	17.355,18	-	-	89,38	19.768,13	-	-

4540X4540	38,72	10.857,95	KBA-35-TNEM	KBS-35-TNET	46,46	11.817,96	KBA-40-TNET	KBS-40-TNET	54,21	13.563,93	KBA-40-TNET	KBS-40-TNET
4540X5540	47,52	12.638,30	KBA-40-TNET	KBS-40-TNET	57,02	13.721,00	KBA-40-TNET	-	66,53	15.692,26	-	-
4540X6540	56,32	14.418,66	KBA-40-TNET	KBS-40-TNET	67,58	15.624,03	-	-	78,85	17.821,81	-	-
4540X7540	65,12	16.200,18	-	-	78,14	17.527,10	-	-	91,17	19.950,13	-	-

4740X4740	42,32	11.580,12	KBA-40-TNET	KBS-40-TNET	50,78	12.589,51	KBA-40-TNET	KBS-40-TNET	59,25	14.426,70	KBA-40-TNET	-
4740X5740	51,52	13.412,98	KBA-40-TNET	KBS-40-TNET	61,82	14.546,64	KBA-40-TNET	-	72,13	16.612,30	-	-
4740X6740	60,72	15.245,84	KBA-40-TNET	-	72,86	16.503,76	-	-	85,01	18.799,13	-	-
4740X7740	69,92	17.078,69	-	-	83,90	18.460,89	-	-	97,89	20.984,73	-	-

4940X4940	46,08	12.323,30	KBA-40-TNET	KBS-40-TNET	55,30	13.383,87	KBA-40-TNET	KBS-40-TNET	64,51	15.312,42	KBA-40-TNET	-
4940X5940	55,68	14.208,66	KBA-40-TNET	KBS-40-TNET	66,82	15.393,92	-	-	77,95	17.555,25	-	-
4940X6940	65,28	16.094,01	-	-	78,34	17.405,13	-	-	91,39	19.798,12	-	-
4940X7740	72,96	17.602,53	-	-	87,55	19.013,18	-	-	102,14	21.592,39	-	-

PORTES PAGADOS





CÁMARAS PANELABLES SUPEREKO (70 mm) REFRIGERACIÓN



DIMENSIONES EXT. (mm)	ALTURA 2140		EQUIPO MONOBLOCK		ALTURA 2540		EQUIPO MONOBLOCK		ALTURA 2940		EQUIPO MONOBLOCK	
	(m³)	PVP	MOCHILA	TECHO	(m³)	PVP	MOCHILA	TECHO	(m³)	PVP	MOCHILA	TECHO
5140X5140	50,00	13.088,64	KBA-40-TNET	KBS-40-TNET	60,00	14.198,73	KBA-40-TNET	-	70,00	16.221,01	-	-
5140X6140	60,00	15.026,50	KBA-40-TNET	-	72,00	16.262,86	-	-	84,00	18.521,12	-	-
5140X7140	70,00	16.963,19	-	-	84,00	18.328,13	-	-	98,00	20.821,26	-	-
5140X7740	76,00	18.126,37	-	-	91,20	19.566,63	-	-	106,40	22.201,33	-	-

5340X5340	54,08	13.873,82	KBA-40-TNET	KBS-40-TNET	64,90	15.035,18	-	-	75,71	17.152,51	-	-
5340X6340	64,48	15.864,17	KBA-40-TNET	-	77,38	17.153,41	-	-	90,27	19.509,89	-	-
5340X7340	74,88	17.853,36	-	-	89,86	19.271,61	-	-	104,83	21.866,04	-	-
5340X7740	79,04	18.649,04	-	-	94,85	20.118,88	-	-	110,66	22.808,99	-	-

PORTES PAGADOS

rövemah



CÁMARAS PANELABLES SUPEREKO (100 mm) CONGELACIÓN



DIMENSIONES EXT. (mm)	ALTURA 2200 (m³) PVP		EQUIPO MONOBLOCK MOCHILA TECHO		ALTURA 2600 (m³) PVP		EQUIPO MONOBLOCK MOCHILA TECHO		ALTURA 3000 (m³) PVP		EQUIPO MONOBLOCK MOCHILA TECHO	
1200X1200	2,00	2.357,08	KBA-10-BTEM	KBS-10-BTEM	2,40	2.651,23	KBA-10-BTEM	KBS-10-BTEM	2,80	3.065,93	KBA-10-BTEM	KBS-10-BTEM
1200X1400	2,40	2.579,08	KBA-10-BTEM	KBS-10-BTEM	2,88	2.897,69	KBA-10-BTEM	KBS-10-BTEM	3,36	3.346,36	KBA-10-BTEM	KBS-10-BTEM
1200X2200	4,00	3.467,10	KBA-10-BTEM	KBS-10-BTEM	4,80	3.884,74	KBA-10-BTEM	KBS-10-BTEM	5,60	4.468,13	KBA-10-BTEM	KBS-10-BTEM
1200X3000	5,60	4.353,92	KBA-10-BTEM	KBS-10-BTEM	6,72	4.870,55	KBA-13-BTEM	KBS-13-BTEM	7,84	5.591,11	KBA-13-BTEM	KBS-13-BTEM
1200X3800	7,20	5.241,94	KBA-13-BTEM	KBS-13-BTEM	8,64	5.856,40	KBA-13-BTEM	KBS-13-BTEM	10,08	6.712,84	KBA-13-BTEM	KBS-18-BTET
1200X4600	8,80	6.129,95	KBA-13-BTEM	KBS-13-BTEM	10,56	6.842,25	KBA-13-BTEM	KBS-18-BTET	12,32	7.835,82	KBA-18-BTEM	KBS-18-BTET
1200X5400	10,40	7.017,97	KBA-13-BTEM	KBS-18-BTET	12,48	7.828,10	KBA-18-BTEM	KBS-18-BTET	14,56	8.957,55	KBA-18-BTEM	KBS-27-BTET
1400X1400	2,88	2.813,09	KBA-10-BTEM	KBS-10-BTEM	3,46	3.157,72	KBA-10-BTEM	KBS-10-BTEM	4,03	3.640,79	KBA-10-BTEM	KBS-10-BTEM
1400X1600	3,36	3.048,29	KBA-10-BTEM	KBS-10-BTEM	4,03	3.417,78	KBA-10-BTEM	KBS-10-BTEM	4,70	3.933,99	KBA-10-BTEM	KBS-10-BTEM
1400X2400	5,28	3.986,71	KBA-10-BTEM	KBS-10-BTEM	6,34	4.455,55	KBA-10-BTEM	KBS-13-BTEM	7,39	5.110,42	KBA-13-BTEM	KBS-13-BTEM
1400X3200	7,20	4.925,13	KBA-13-BTEM	KBS-13-BTEM	8,64	5.493,33	KBA-13-BTEM	KBS-13-BTEM	10,08	6.285,61	KBA-13-BTEM	KBS-18-BTET
1400X4000	9,12	5.863,55	KBA-13-BTEM	KBS-18-BTET	10,94	6.531,10	KBA-18-BTEM	KBS-18-BTET	12,77	7.462,04	KBA-18-BTEM	KBS-27-BTET
1400X4800	11,04	6.801,96	KBA-18-BTEM	KBS-18-BTET	13,25	7.568,88	KBA-18-BTEM	KBS-27-BTET	15,46	8.637,23	KBA-27-BTEM	KBS-27-BTET
1400X5400	12,46	7.505,18	KBA-18-BTEM	KBS-27-BTET	14,98	8.347,79	KBA-27-BTEM	KBS-27-BTET	17,47	9.519,26	KBA-27-BTEM	KBS-27-BTET
1600X1600	3,92	3.295,49	KBA-10-BTEM	KBS-10-BTEM	4,70	3.690,20	KBA-10-BTEM	KBS-10-BTEM	5,49	4.242,39	KBA-10-BTEM	KBS-10-BTEM
1600X1800	4,48	3.542,70	KBA-10-BTEM	KBS-10-BTEM	5,38	3.962,63	KBA-10-BTEM	KBS-10-BTEM	6,27	4.549,55	KBA-10-BTEM	KBS-13-BTEM
1600X2600	6,72	4.531,52	KBA-13-BTEM	KBS-13-BTEM	8,06	5.052,33	KBA-13-BTEM	KBS-13-BTEM	9,41	5.778,20	KBA-13-BTEM	KBS-18-BTET
1600X3400	8,96	5.520,34	KBA-13-BTEM	KBS-13-BTEM	10,75	6.142,02	KBA-18-BTEM	KBS-18-BTET	12,54	7.008,08	KBA-18-BTEM	KBS-27-BTET
1600X4200	11,20	6.509,15	KBA-18-BTEM	KBS-18-BTET	13,44	7.232,92	KBA-18-BTEM	KBS-27-BTET	15,68	8.236,76	KBA-27-BTEM	KBS-27-BTET
1600X5000	13,44	7.497,97	KBA-18-BTEM	KBS-27-BTET	16,13	8.322,62	KBA-27-BTEM	KBS-27-BTET	18,82	9.466,64	KBA-27-BTEM	KBS-27-BTET
1600X5400	14,56	7.992,38	KBA-18-BTEM	KBS-27-BTET	17,47	8.867,47	KBA-27-BTEM	KBS-27-BTET	20,38	10.080,96	KBA-27-BTEM	KBS-27-BTET
1800X1800	5,12	3.801,90	KBA-10-BTEM	KBS-10-BTEM	6,14	4.247,41	KBA-10-BTEM	KBS-13-BTEM	7,17	4.869,44	KBA-13-BTEM	KBS-13-BTEM
1800X2000	5,76	4.062,31	KBA-10-BTEM	KBS-13-BTEM	6,91	4.533,44	KBA-13-BTEM	KBS-13-BTEM	8,06	5.190,60	KBA-13-BTEM	KBS-13-BTEM
1800X2800	8,32	5.101,53	KBA-13-BTEM	KBS-13-BTEM	9,98	5.675,06	KBA-13-BTEM	KBS-18-BTET	11,65	6.473,94	KBA-18-BTEM	KBS-18-BTET
1800X3600	10,88	6.140,75	KBA-18-BTEM	KBS-18-BTET	13,06	6.817,89	KBA-18-BTEM	KBS-27-BTET	15,23	7.756,07	KBA-27-BTEM	KBS-27-BTET
1800X4400	13,44	7.181,16	KBA-18-BTEM	KBS-27-BTET	16,13	7.959,54	KBA-27-BTEM	KBS-27-BTET	18,82	9.039,41	KBA-27-BTEM	KBS-27-BTET
1800X5200	16,00	8.220,38	KBA-27-BTEM	KBS-27-BTET	19,20	9.102,37	KBA-27-BTEM	KBS-27-BTET	22,40	10.322,78	KBA-31-BTET	KBS-30-BTST
1800X5400	16,64	8.479,59	KBA-27-BTEM	KBS-27-BTET	19,97	9.387,16	KBA-27-BTEM	KBS-27-BTET	23,30	10.642,67	KBA-31-BTET	KBS-30-BTST

PORTES PAGADOS





CÁMARAS PANELABLES SUPEREKO (100 mm) CONGELACIÓN

TECNODOM spa
refrigerazione

CAMARAS FRIGORIFICAS



DIMENSIONES EXT. (mm)	ALTURA 2200		EQUIPO MONOBLOCK		ALTURA 2600		EQUIPO MONOBLOCK		ALTURA 3000		EQUIPO MONOBLOCK	
	(m³)	PVP	MOCHILA	TECHO	(m³)	PVP	MOCHILA	TECHO	(m³)	PVP	MOCHILA	TECHO
2000X2000	6,48	4.334,71	KBA-13-BTEM	KBS-13-BTEM	7,78	4.831,83	KBA-13-BTEM	KBS-13-BTEM	9,07	5.524,49	KBA-13-BTEM	KBS-18-BTET
2000X2200	7,20	4.607,12	KBA-13-BTEM	KBS-13-BTEM	8,64	5.130,21	KBA-13-BTEM	KBS-13-BTEM	10,08	5.858,38	KBA-13-BTEM	KBS-18-BTET
2000X3000	10,08	5.696,74	KBA-13-BTEM	KBS-18-BTET	12,10	6.324,96	KBA-18-BTEM	KBS-18-BTET	14,11	7.195,20	KBA-18-BTEM	KBS-27-BTET
2000X3800	12,96	6.787,55	KBA-18-BTEM	KBS-27-BTET	15,55	7.518,54	KBA-27-BTEM	KBS-27-BTET	18,14	8.531,99	KBA-27-BTEM	KBS-27-BTET
2000X4600	15,84	7.877,17	KBA-27-BTEM	KBS-27-BTET	19,01	8.713,29	KBA-27-BTEM	KBS-27-BTET	22,18	9.868,82	KBA-31-BTET	KBS-30-BTST
2000X5400	18,72	8.966,79	KBA-27-BTEM	KBS-27-BTET	22,46	9.908,04	KBA-31-BTET	KBS-30-BTST	26,21	11.205,64	KBA-35-BTET	KBS-35-BTST
2200X2200	8,00	4.892,72	KBA-13-BTEM	KBS-13-BTEM	9,60	5.442,20	KBA-13-BTEM	KBS-18-BTET	11,20	6.206,27	KBA-18-BTEM	KBS-18-BTET
2200X2400	8,80	5.177,13	KBA-13-BTEM	KBS-13-BTEM	10,56	5.754,15	KBA-13-BTEM	KBS-18-BTET	12,32	6.554,15	KBA-18-BTEM	KBS-27-BTET
2200X3200	12,00	6.318,35	KBA-18-BTEM	KBS-18-BTET	14,40	6.999,66	KBA-18-BTEM	KBS-27-BTET	16,80	7.944,40	KBA-27-BTEM	KBS-27-BTET
2200X4000	15,20	7.458,36	KBA-27-BTEM	KBS-27-BTET	18,24	8.246,33	KBA-27-BTEM	KBS-27-BTET	21,28	9.334,68	KBA-31-BTET	KBS-27-BTET
2200X4800	18,40	8.599,58	KBA-27-BTEM	KBS-27-BTET	22,08	9.493,04	KBA-31-BTET	KBS-30-BTST	25,76	10.724,96	KBA-31-BTET	KBS-35-BTST
2200X5400	20,80	9.455,20	KBA-27-BTEM	KBS-27-BTET	24,96	10.427,76	KBA-31-BTET	KBS-35-BTST	29,12	11.767,35	KBA-34-BTET	KBS-35-BTST
2400X2400	9,68	5.474,73	KBA-13-BTEM	KBS-18-BTET	11,62	6.078,50	KBA-18-BTEM	KBS-18-BTET	13,55	6.914,77	KBA-18-BTEM	KBS-27-BTET
2400X2600	10,56	5.773,54	KBA-13-BTEM	KBS-18-BTET	12,67	6.402,88	KBA-18-BTEM	KBS-27-BTET	14,78	7.275,38	KBA-27-BTEM	KBS-27-BTET
2400X3400	14,08	6.963,95	KBA-18-BTEM	KBS-27-BTET	16,90	7.701,48	KBA-27-BTEM	KBS-27-BTET	19,71	8.719,12	KBA-27-BTEM	KBS-27-BTET
2400X4200	17,60	8.155,57	KBA-27-BTEM	KBS-27-BTET	21,12	9.000,11	KBA-31-BTET	KBS-30-BTST	24,64	10.162,85	KBA-31-BTET	KBS-35-BTST
2400X5000	21,12	9.345,99	KBA-31-BTET	KBS-30-BTST	25,34	10.297,51	KBA-31-BTET	KBS-35-BTST	29,57	11.606,55	KBA-34-BTET	KBS-35-BTST
2400X5400	22,88	9.942,40	KBA-31-BTET	KBS-30-BTST	27,46	10.947,44	KBA-34-BTET	KBS-35-BTST	32,03	12.329,05	KBA-34-BTET	KBS-35-BTST
2600X2600	11,52	5.838,34	KBA-18-BTEM	KBS-18-BTET	13,82	6.461,05	KBA-18-BTEM	KBS-27-BTET	16,13	7.332,76	KBA-27-BTEM	KBS-27-BTET
2600X3600	16,32	7.326,36	KBA-27-BTEM	KBS-27-BTET	19,58	8.076,81	KBA-27-BTEM	KBS-27-BTET	22,85	9.124,55	KBA-31-BTET	KBS-30-BTST
2600X4600	21,12	8.814,39	KBA-31-BTET	KBS-30-BTST	25,34	9.692,57	KBA-31-BTET	KBS-35-BTST	29,57	10.916,34	KBA-34-BTET	KBS-35-BTST
2600X5600	26,88	10.301,21	KBA-34-BTET	KBS-35-BTST	32,26	11.309,53	KBA-34-BTET	KBS-35-BTST	37,63	12.708,21	KBA-34-BTET	KBS-42-BTST
2600X6800	31,68	12.086,84	KBA-34-BTET	KBS-35-BTST	38,02	13.248,41	KBA-34-BTET	KBS-42-BTST	44,35	14.859,31	-	KBS-42-BTST
2600X7800	36,48	13.573,66	KBA-34-BTET	KBS-42-BTST	43,78	14.865,33	-	KBS-42-BTST	51,07	16.651,14	-	-

PORTES PAGADOS



CÁMARAS PANELABLES SUPEREKO (100 mm) CONGELACIÓN



TECNODOM spa
refrigerazione

DIMENSIONES EXT. (mm)	ALTURA 2200 (m³)		EQUIPO MONOBLOCK MOCHILA		ALTURA 2600 (m³)		EQUIPO MONOBLOCK TECHO		ALTURA 3000 (m³)		EQUIPO MONOBLOCK TECHO	
	PVP				PVP				PVP			
2800X2800	13,52	6.445,55	KBA-18-BTEM	KBS-27-BTET	16,22	7.119,71	KBA-27-BTEM	KBS-27-BTET	18,93	8.061,71	KBA-27-BTEM	KBS-27-BTET
2800X3800	18,72	7.993,57	KBA-27-BTEM	KBS-27-BTET	22,46	8.798,49	KBA-31-BTET	KBS-30-BTST	26,21	9.918,41	KBA-34-BTET	KBS-35-BTST
2800X4800	23,92	9.541,60	KBA-31-BTET	KBS-35-BTST	28,70	10.476,07	KBA-34-BTET	KBS-35-BTST	33,49	11.773,84	KBA-34-BTET	KBS-42-BTST
2800X5800	29,12	11.089,62	KBA-34-BTET	KBS-35-BTST	34,94	12.154,84	KBA-34-BTET	KBS-42-BTST	40,77	13.630,54	KBA-34-BTET	KBS-42-BTST
2800X6800	34,32	12.637,64	KBA-34-BTET	KBS-42-BTST	41,18	13.833,62	KBA-34-BTET	KBS-42-BTST	48,05	15.487,24	-	-
2800X7800	39,52	14.185,66	KBA-34-BTET	KBS-42-BTST	47,42	15.512,39	-	-	55,33	17.342,70	-	-
3000X3000	15,68	6.744,36	KBA-27-BTEM	KBS-27-BTET	18,82	7.424,73	KBA-27-BTEM	KBS-27-BTET	21,95	8.389,67	KBA-34-BTET	KBS-30-BTST
3000X4000	21,28	8.275,58	KBA-31-BTET	KBS-30-BTST	25,54	9.079,02	KBA-31-BTET	KBS-35-BTST	29,79	10.214,76	KBA-34-BTET	KBS-35-BTST
3000X5000	26,88	9.805,60	KBA-34-BTET	KBS-35-BTST	32,26	10.734,47	KBA-34-BTET	KBS-35-BTST	37,63	12.039,90	KBA-34-BTET	KBS-42-BTST
3000X6000	33,60	11.336,83	KBA-34-BTET	KBS-42-BTST	40,32	12.388,79	KBA-34-BTET	KBS-42-BTST	47,04	13.865,04	-	-
3000X7000	39,20	12.866,85	KBA-34-BTET	KBS-42-BTST	47,04	14.043,04	-	-	54,88	15.690,13	-	-
3000X7800	42,56	14.090,87	-	KBS-42-BTST	51,07	15.366,64	-	-	59,58	17.150,66	-	-
3200X3200	18,00	7.368,37	KBA-27-BTEM	KBS-27-BTET	21,60	8.098,31	KBA-31-BTET	KBS-30-BTST	25,20	9.131,43	KBA-31-BTET	KBS-35-BTST
3200X4200	24,00	8.955,99	KBA-31-BTET	KBS-35-BTST	28,80	9.811,91	KBA-34-BTET	KBS-35-BTST	33,60	11.017,62	KBA-34-BTET	KBS-42-BTST
3200X5200	30,00	10.544,81	KBA-34-BTET	KBS-35-BTST	36,00	11.525,54	KBA-34-BTET	KBS-42-BTST	42,00	12.903,80	-	KBS-42-BTST
3200X6200	36,00	12.132,44	KBA-34-BTET	KBS-42-BTST	43,20	13.240,33	-	KBS-42-BTST	50,40	14.790,03	-	-
3200X7200	42,00	13.720,06	-	KBS-42-BTST	50,40	14.953,92	-	-	58,80	16.676,21	-	-
3200X7800	45,60	14.672,87	-	-	54,72	15.981,61	-	-	63,84	17.807,91	-	-
3400X3400	20,48	8.015,18	KBA-27-BTEM	KBS-30-BTST	24,58	8.795,39	KBA-31-BTET	KBS-35-BTST	28,67	9.898,61	KBA-34-BTET	KBS-35-BTST
3400X4400	26,88	9.660,40	KBA-34-BTET	KBS-35-BTST	32,26	10.568,32	KBA-34-BTET	KBS-42-BTST	37,63	11.845,89	KBA-34-BTET	KBS-42-BTST
3400X5400	33,28	11.305,62	KBA-34-BTET	KBS-42-BTST	39,94	12.341,26	KBA-34-BTET	KBS-42-BTST	46,59	13.793,17	-	-
3400X6400	39,68	12.952,05	KBA-34-BTET	KBS-42-BTST	47,62	14.115,43	-	-	55,55	15.739,25	-	-
3400X7400	46,08	14.597,27	-	-	55,30	15.888,37	-	-	64,51	17.686,52	-	-

PORTES PAGADOS





CÁMARAS PANELABLES SUPEREKO (100 mm) CONGELACIÓN



DIMENSIONES EXT. (mm)	ALTURA 2200		EQUIPO MONOBLOCK		ALTURA 2600		EQUIPO MONOBLOCK		ALTURA 3000		EQUIPO MONOBLOCK	
	(m ³)	PVP	MOCHILA	TECHO	(m ³)	PVP	MOCHILA	TECHO	(m ³)	PVP	MOCHILA	TECHO
3600X3600	23,12	8.684,79	KBA-31-BTET	KBS-35-BTST	27,74	9.517,15	KBA-34-BTET	KBS-35-BTST	32,37	10.690,01	KBA-34-BTET	KBS-42-BTST
3600X4600	29,92	10.387,61	KBA-34-BTET	KBS-35-BTST	35,90	11.349,43	KBA-34-BTET	KBS-42-BTST	41,89	12.697,14	-	KBS-42-BTST
3600X5600	36,72	12.090,43	KBA-34-BTET	KBS-42-BTST	44,06	13.181,71	-	KBS-42-BTST	51,41	14.705,51	-	-
3600X6600	43,52	13.793,25	-	KBS-42-BTST	52,22	15.013,99	-	-	60,93	16.713,88	-	-
3600X7600	50,32	15.497,28	-	-	60,38	16.846,31	-	-	70,45	18.722,25	-	-

3800X3800	25,92	9.377,20	KBA-34-BTET	KBS-35-BTST	31,10	10.261,20	KBA-34-BTET	KBS-35-BTST	36,29	11.504,32	KBA-34-BTET	KBS-42-BTST
3800X4800	33,12	11.137,62	KBA-34-BTET	KBS-42-BTST	39,74	12.152,83	KBA-34-BTET	KBS-42-BTST	46,37	13.573,78	-	-
3800X5800	40,32	12.898,04	KBA-34-BTET	KBS-42-BTST	48,38	14.044,45	-	-	56,45	15.643,24	-	-
3800X6800	47,52	14.658,46	-	-	57,02	15.936,08	-	-	66,53	17.711,47	-	-
3800X7800	54,72	16.418,89	-	-	65,66	17.827,70	-	-	76,61	19.780,93	-	-

4000X4000	28,88	10.093,60	KBA-34-BTET	KBS-35-BTST	34,66	11.029,98	KBA-34-BTET	KBS-42-BTST	40,43	12.344,08	KBA-34-BTET	KBS-42-BTST
4000X5000	36,48	11.911,63	KBA-34-BTET	KBS-42-BTST	43,78	12.980,95	-	KBS-42-BTST	51,07	14.474,64	-	-
4000X6000	44,08	13.729,65	-	KBS-42-BTST	52,90	14.931,92	-	-	61,71	16.605,19	-	-
4000X7000	51,68	15.547,67	-	-	62,02	16.881,69	-	-	72,35	18.734,47	-	-
4000X7800	57,76	17.002,09	-	-	69,31	18.442,70	-	-	80,86	20.438,18	-	-

4200X4200	32,00	10.831,61	KBA-34-BTET	KBS-35-BTST	38,40	11.822,22	KBA-34-BTET	KBS-42-BTST	44,80	13.209,26	-	KBS-42-BTST
4200X5200	40,00	12.707,24	KBA-34-BTET	KBS-42-BTST	48,00	13.832,53	-	-	56,00	15.399,67	-	-
4200X6200	48,00	14.582,86	-	-	57,60	15.841,64	-	-	67,20	17.591,28	-	-
4200X7200	56,00	16.458,48	-	-	67,20	17.851,95	-	-	78,40	19.781,69	-	-
4200X7800	60,80	17.584,10	-	-	72,96	19.057,66	-	-	85,12	21.096,66	-	-

PORTES PAGADOS



CÁMARAS PANELABLES SUPEREKO (100 mm) CONGELACIÓN



DIMENSIONES EXT. (mm)	ALTURA 2200 (m³) PVP		EQUIPO MONOBLOCK MOCHILA TECHO		ALTURA 2600 (m³) PVP		EQUIPO MONOBLOCK MOCHILA TECHO		ALTURA 3000 (m³) PVP		EQUIPO MONOBLOCK MOCHILA TECHO	
4400X4400	35,28	11.593,62	KBA-34-BTET	KBS-42-BTST	42,34	12.637,98	-	KBS-42-BTST	49,39	14.097,39	-	-
4400X5400	43,68	13.526,85	-	KBS-42-BTST	52,42	14.707,63	-	-	61,15	16.348,89	-	-
4400X6400	52,08	15.458,87	-	-	62,50	16.776,05	-	-	72,91	18.601,59	-	-
4400X7400	60,48	17.392,09	-	-	72,58	18.845,71	-	-	84,67	20.853,10	-	-
4400X7800	63,84	18.166,10	-	-	76,61	19.672,63	-	-	89,38	21.753,91	-	-
4600X4600	38,72	12.378,43	KBA-34-BTET	KBS-42-BTST	46,46	13.477,23	-	-	54,21	15.010,94	-	-
4600X5600	47,52	14.368,05	-	-	57,02	15.606,19	-	-	66,53	17.323,53	-	-
4600X6600	56,32	16.358,88	-	-	67,58	17.733,99	-	-	78,85	19.636,09	-	-
4600X7600	65,12	18.349,70	-	-	78,14	19.862,99	-	-	91,17	21.948,68	-	-
4800X4800	42,32	13.186,04	-	KBS-42-BTST	50,78	14.341,17	-	-	59,25	15.947,47	-	-
4800X5800	51,52	15.233,26	-	-	61,82	16.528,27	-	-	72,13	18.321,11	-	-
4800X6800	60,72	17.281,69	-	-	72,86	18.715,42	-	-	85,01	20.696,00	-	-
4800X7800	69,92	19.330,11	-	-	83,90	20.903,76	-	-	97,89	23.069,68	-	-
5000X5000	46,08	14.016,45	-	-	55,30	15.227,40	-	-	64,51	16.909,38	-	-
5000X6000	55,68	16.122,47	-	-	66,82	17.473,89	-	-	77,95	19.344,12	-	-
5000X7000	65,28	18.227,30	-	-	78,34	19.721,53	-	-	91,39	21.778,89	-	-
5000X7800	72,96	19.912,11	-	-	87,55	21.518,72	-	-	102,14	23.726,93	-	-
5200X5200	50,00	14.869,66	-	-	60,00	16.138,32	-	-	70,00	17.895,51	-	-
5200X6200	60,00	17.033,28	-	-	72,00	18.444,15	-	-	84,00	20.391,34	-	-
5200X7200	70,00	19.195,71	-	-	84,00	20.749,94	-	-	98,00	22.887,17	-	-
5200X7800	76,00	20.494,12	-	-	91,20	22.133,69	-	-	106,40	24.385,42	-	-
5400X5400	54,08	15.746,87	-	-	64,90	17.072,77	-	-	75,71	18.905,82	-	-
5400X6400	64,48	17.966,89	-	-	77,38	19.437,90	-	-	90,27	21.462,74	-	-
5400X7400	74,88	20.188,11	-	-	89,86	21.803,08	-	-	104,83	24.019,67	-	-
5400X7800	79,04	21.076,12	-	-	94,85	22.748,65	-	-	110,66	25.042,67	-	-

PORTES PAGADOS





CÁMARAS FRIGORÍFICAS MONOBLOCKS

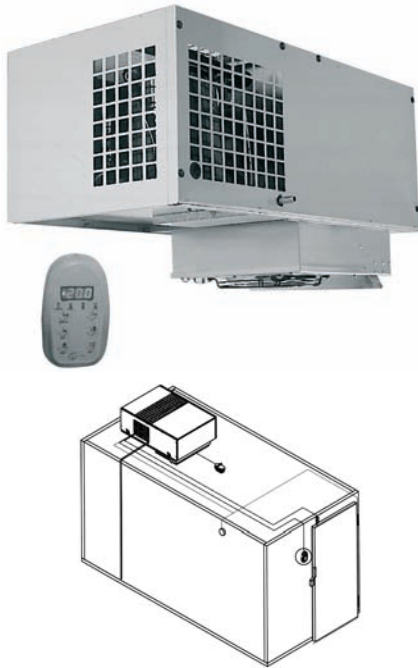

MONOBLOCK BAJA Y ALTA TEMPERATURA TECHO



MONOBLOCK BAJA Y ALTA TEMPERATURA MOCHILA

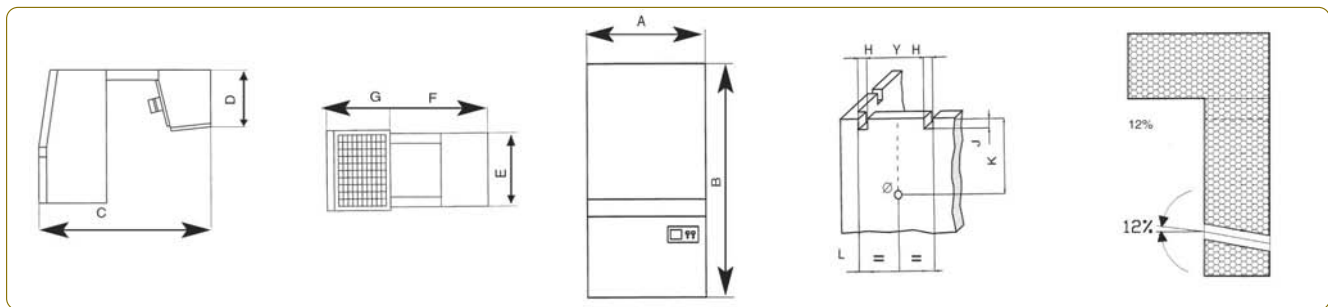

MONOBLOCK MOCHILA

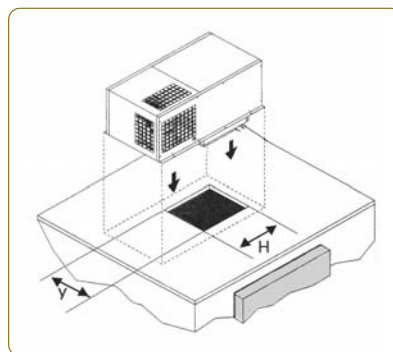
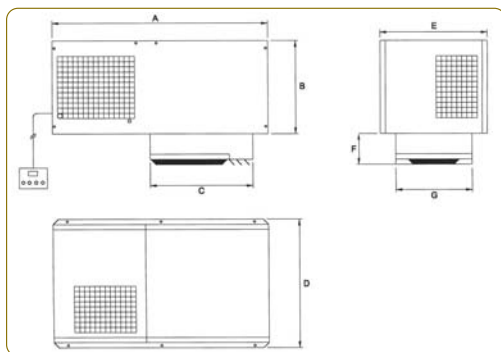

MONOBLOCK TECHO



CÁMARAS FRIGORÍFICAS MONOBLOCKS ALTA TEMPERATURA



MONOBLOCKS ALTA TEMPERATURA R-404A “MOCHILA”

MODELO	VOLTAJE (V/Hz)	TEMP. AMBIENTE EXTERIOR (°C)	Tª INTERIOR CAMARA, RENDIMIENTO EN WATIOS								CV	DIMENSIONES (mm) MONTAJE (mm)											
			(-5°C)		(0°C)		(5°C)		(10°C)			A	B	C	D	E	F	G	H	Y	J	K	L
KBA-08-TNEM	230/50	35	4,37	675	4,7	726	5,08	784	5,48	846	0,4	322	617	748	292	300	438	310	40	273	40	257	centro
	45	3,7	571	4,02	621	4,34	671	4,69	724														
KBA-11-TNEM	230/50	35	6,56	927	7,05	996	7,61	1076	8,22	1162	0,5	450	700	900	350	332	540	360	40	337	43	327	centro
	45	5,55	784	6,03	853	6,51	921	7,04	994														
KBA-13-TNEM	230/50	35	10,05	1080	10,81	1161	11,67	1254	12,61	1354	0,75	450	700	900	350	332	540	360	40	337	43	327	centro
	45	8,51	914	9,25	993	9,99	1073	10,79	1159														
KBA-17-TNEM	230/50	35	13,11	1451	14,1	1560	15,23	1685	16,45	1820	1	450	700	900	350	332	540	360	40	337	43	327	centro
	45	11,1	1228	12,06	1335	13,03	1442	14,07	1557														
KBA-20-TNEM	230/50	35	14,86	1727	15,98	1857	17,26	2006	18,64	2167	1	645	830	903	350	612	535	360	50	605	63	431	centro
	45	12,58	1462	13,67	1589	14,77	1716	15,95	1854														
KBA-25-TNEM	230/50	35	18,36	2089	19,74	2247	21,32	2426	23,02	2620	1,2	645	830	903	350	690	615	345	50	667	63	431	centro
	45	15,54	1846	16,89	1985	18,24	2144	19,7	2315														
KBA-32-TNEM	230/50	35	27,54	2622	26,91	2819	31,98	3045	34,54	3288	1,5	800	830	903	350	690	615	345	50	667	63	431	centro
	45	23,31	2219	25,33	2412	27,36	2605	29,55	2813														
KBA-35-TNEM	230/50	35	38,9	2964	41,83	3187	45,18	3442	48,79	3717	1,9	1150	830	908	280	1145	615	360	50	667	63	431	centro
	45	32,93	2508	35,79	2726	38,65	2945	41,75	3180														
KBA-40-TNET	400/50	35	59,45	3366	63,92	3619	69,03	3909	74,56	4221	2,4	1150	830	908	280	1145	615	360	50	1017	63	431	centro
	45	50,31	2849	54,69	3096	59,07	3344	63,79	3612														

MONOBLOCKS ALTA TEMPERATURA R-404A “TECHO”

MODELO	VOLTAJE (V/Hz)	TEMP. AMBIENTE EXTERIOR (°C)	Tª INTERIOR CAMARA, RENDIMIENTO EN WATIOS								CV	DIMENSIONES (mm) MONTAJE (mm)								
			(-5°C)		(0°C)		(5°C)		(10°C)			A	B	C	D	Y				
KBS-08-TNEM	230/50	35	3,5	700	3,75	750	4	810	4,4	880	0,4	855	360	355	490	438	140	352	365	365
	45	2,9	590	3,2	640	3,5	700	3,7	750											
KBS-11-TNEM	230/50	35	5,6	930	6,1	1000	6,6	1080	7,13	1160	0,5	1005	400	448	567	515	192	412	420	450
	45	4,8	780	5,2	850	5,65	920	6,1	990											
KBS-13-TNEM	230/50	35	9,1	1275	9,8	1370	10,65	1480	11,5	1600	0,75	1005	400	448	567	515	192	412	420	450
	45	7,7	1080	8,4	1170	9,1	1270	9,8	1370											
KBS-17-TNEM	230/50	35	12,2	1430	13,15	1540	14,2	1670	15,35	1800	1	1005	400	448	567	515	192	412	420	450
	45	10,3	1210	11,2	1320	12,1	1430	13,10	1540											
KBS-20-TNEM	230/50	35	15,3	1570	16,4	1690	17,7	1830	19,1	1970	1	1200	400	448	917	865	192	762	766	450
	45	12,9	1330	14	1450	15,2	1560	16,4	1690											
KBS-25-TNEM	230/50	35	18,3	1960	19,7	2110	21,3	2270	23	2460	1,2	1200	400	448	917	865	192	762	766	450
	45	15,5	1660	16,8	1800	18,2	1940	19,7	2100											
KBS-32-TNEM	230/50	35	26,2	2790	28,2	3000	30,4	3240	32,8	3500	1,5	1200	400	448	917	865	192	762	766	450
	45	22	2360	24	2570	26	2770	28	2990											
KBS-35-TNET	400/50	35	37	3030	40	3260	43	3520	46,6	3810	1,9	1200	400	448	1252	1252	192	1112	1110	450
	45	31,4	2570	34	2790	36,9	3010	39,8	3260											
KBS-40-TNET	400/50	35	51	3740	55	4020	59	4350	64	4690	2,4	1200	400	448	1252	1252	192	1112	1110	450
	45	43	3170	47	3420	51	3720	55	4015											



CÁMARAS FRIGORÍFICAS MONOBLOCKS ALTA TEMPERATURA

MONOBLOCKS ALTA TEMPERATURA R-404A “MOCHILA”

MODELO	DESAGÜE (Ø)	PESO (Kg)	COMPRESOR HERMÉTICO		CONDENSADOR			EVAPORADOR			DESCARCHE POR GAS CALIENTE	VÁLVULA EXPANSIÓN
			POTENCIA NOMINAL (CV)	TENSIÓN (50Hz)	I Nº	Ø	W/u	I Nº	Ø	W/u		
KBA-08-TNEM	30	34	0,4	1230 V	1	230	31	1	230	40	si	no
KBA-11-TNEM	30	58	0,5	1230 V	1	254	73	1	254	73	si	no
KBA-13-TNEM	30	60	0,75	1230 V	1	254	73	1	254	73	si	no
KBA-17-TNEM	30	64	1	1230 V	1	254	73	1	254	73	si	no
KBA-20-TNEM	30	85	1	1230 V	1	300	110	1	300	110	si	si
KBA-25-TNEM	30	94	1,2	1230 V	2	254	146	2	254	73	si	si
KBA-32-TNEM	30	98	1,5	1230 V	2	254	146	2	254	73	si	si
KBA-35-TNEM	30	145	1,9	1230 V	3	254	146	3	254	73	si	si
KBA-40-TNET	30	148	2,4	III 400 V	3	254	219	3	254	279	si	si

MONOBLOCKS ALTA TEMPERATURA R-404A “TECHO”

MODELO	DESAGÜE (Ø)	PESO (Kg)	COMPRESOR HERMÉTICO		CONDENSADOR			EVAPORADOR			DESCARCHE POR GAS CALIENTE	VÁLVULA EXPANSIÓN
			POTENCIA NOMINAL (CV)	TENSIÓN (50Hz)	I Nº	Ø	W/u	I Nº	Ø	W/u		
KBS-08-TNEM	30	57	0,4	1230 V	1	254	73	1	254	73	si	no
KBS-11-TNEM	30	58	0,5	1230 V	1	254	73	1	254	73	si	no
KBS-13-TNEM	30	65	0,75	1230 V	1	254	73	1	254	73	si	no
KBS-17-TNEM	30	67	1	1230 V	1	254	73	1	254	73	si	no
KBS-20-TNEM	30	98	1	1230 V	2	254	146	2	254	146	si	si
KBS-25-TNEM	30	102	1,2	1230 V	2	254	146	2	254	146	si	si
KBS-32-TNEM	30	110	2	1230 V	2	254	146	2	254	146	si	si
KBS-35-TNET	30	154	1,9	III 400 V	3	254	219	3	254	219	si	si
KBS-40-TNET	30	165	2,4	III 400 V	3	254	219	3	254	219	si	si



CÁMARAS FRIGORÍFICAS MONOBLOCKS BAJA TEMPERATURA



MONOBLOCKS BAJA TEMPERATURA R-404A “MOCHILA”

MODELO	VOLTAJE (V/Hz)	TEMP. AMBIENTE EXTERIOR (°C)	Tª INTERIOR CAMARA, RENDIMIENTO EN WATIOS						CV	DIMENSIONES (mm) MONTAJE (mm)													
			(-22°C)		(-20°C)		(-18°C)			A	B	C	D	E	F	G	H	Y	J	K	L		
			m³	Watt	m³	Watt	m³	Watt															
KBA-10-BTEM	230/50	35	5,68	810	6,11	870	6,6	940	1,2	450	700	900	350	332	540	360	40	337	43	327	centro		
		45	4,81	685	5,23	745	5,65	804															
KBA-13-BTEM	230/50	35	9,18	1075	9,87	1156	10,66	1249	1,7	450	700	900	350	332	540	360	40	337	43	327	centro		
		45	7,77	910	8,44	989	9,12	1068															
KBA-18-BTEM	230/50	35	13,1	1533	14,1	1649	15,23	1781	1,8	645	830	903	345	612	535	360	50	605	63	431	centro		
		45	11,1	1298	12,06	1411	13,03	1524															
KBA-27-BTEM	230/50	35	18,8	2336	20,21	2512	21,83	2713	2,4	800	830	901	350	690	615	345	50	605	60	431	centro		
		45	15,91	1977	17,29	2149	18,68	2321															
KBA-31-BTET	400/50	35	23,6	2553	25,38	2745	27,41	2964	3,3	1170	830	908	290	1145	615	360	50	1017	63	421	centro		
		45	19,98	2161	21,72	2348	23,45	2536															
KBA-34-BTET	400/50	35	37,59	2894	40,42	3111	43,65	3360	3,5	1170	830	908	290	1145	615	360	50	1017	63	421	centro		
		45	31,82	2449	34,58	2662	37,35	2875															

MONOBLOCKS BAJA TEMPERATURA R-404A “TECHO”

MODELO	VOLTAJE (V/Hz)	TEMP. AMBIENTE EXTERIOR (°C)	Tª INTERIOR CAMARA, RENDIMIENTO EN WATIOS						CV	DIMENSIONES (mm) MONTAJE (mm)											
			(-22°C)		(-20°C)		(-18°C)			A	B	C	D	E	F	G	H	Y			
			m³	Watt	m³	Watt	m³	Watt													
KBS-07-BTEM	230/50	35	2,5	610	2,5	660	3	710	1	1005	400	448	567	515	192	412	420	450			
		45	2	520	2,2	560	2,5	610													
KBS-10-BTEM	230/50	35	4,8	840	5	900	5,6	980	1,2	1005	400	448	567	515	192	412	420	450			
		45	4	710	4,4	770	4,7	830													
KBS-13-BTEM	230/50	35	7,8	1140	8,4	1220	9	1320	1,7	1005	400	448	567	515	192	412	420	450			
		45	6,6	960	7,2	1050	7,8	1130													
KBS-18-BTEM	400/50	35	10,9	1220	11,7	1320	12,6	1420	1,9	1200	400	448	917	865	192	762	420	450			
		45	9,2	1040	10	1130	10,8	1220													
KBS-27-BTET	400/50	35	18,3	1810	19,7	1950	21,3	2100	2,4	1200	400	448	917	865	192	762	766	450			
		45	15,5	1530	16,8	1670	18,2	1800													
KBS-30-BTST	400/50	35	20,9	2640	22,5	2840	24,3	3070	2	1200	400	448	917	865	192	762	766	450			
		45	17,7	2240	19,3	2430	20,8	2620													
KBS-35-BTST	400/50	35	30	3020	32,4	3240	35	3500	2	1200	400	448	1252	1252	192	1112	1110	450			
		45	25,5	2550	27,7	2780	29,9	3000													
KBS-42-BTST	400/50	35	40,6	3630	43,7	3900	47,2	4210	3	1200	400	448	1252	1252	192	1112	1110	450			
		45	34,4	3070	37,4	3340	40,3	3610													



CÁMARAS FRIGORÍFICAS MONOBLOCKS BAJA TEMPERATURA



MONOBLOCKS ALTA TEMPERATURA R-404A “MOCHILA”

MODELO	DESAGÜE (Ø)	PESO (Kg)	COMPRESOR HERMÉTICO		CONDENSADOR			EVAPORADOR			DESCARCHE POR GAS CALIENTE	VÁLVULA EXPANSIÓN
			POTENCIA NOMINAL (CV)	TENSIÓN (50Hz)	I 230 V 50Hz (VENTILADORES) Nº	Ø	W/u	I 230 V 50Hz (VENTILADORES) Nº	Ø	W/u		
KBA-10-BTEM	30	65	1,2	I 230 V	1	254	73	1	254	73	si	si
KBA-13-BTEM	30	70	1,7	I 230 V	1	254	73	1	254	73	si	si
KBA-18-BTEM	30	102	1,8	I 230 V	1	300	110	1	300	110	si	si
KBA-27-BTEM	30	145	2,4	I 230 V	2	254	146	2	254	146	si	si
KBA-31-BTET	30	168	3,3	III 400 V	3	254	219	3	254	219	si	si
KBA-34-BTET	30	168	3,5	III 230 V	3	254	219	3	254	219	si	si

MONOBLOCKS BAJA TEMPERATURA R-404A “TECHO”

MODELO	DESAGÜE (Ø)	PESO (Kg)	COMPRESOR HERMÉTICO		CONDENSADOR			EVAPORADOR			DESCARCHE POR GAS CALIENTE	VÁLVULA EXPANSIÓN
			POTENCIA NOMINAL (CV)	TENSIÓN (50Hz)	I 230 V 50Hz (VENTILADORES) Nº	Ø	W/u	I 230 V 50Hz (VENTILADORES) Nº	Ø	W/u		
KBS-07-BTEM	30	57	1	I 230 V	1	254	73	1	254	73	si	si
KBS-10-BTEM	30	60	1,2	I 230 V	1	254	73	1	254	73	si	si
KBS-13-BTEM	30	68	1,7	I 230 V	1	254	73	1	254	73	si	si
KBS-18-BTEM	30	115	1,9	IIII 400 V	2	254	146	2	254	146	si	si
KBS-27-BTET	30	125	2,4	III 400 V	2	254	146	2	254	146	si	si
KBS-30-BTST	30	150	2	III 400 V	2	254	146	2	254	146	si	si
KBS-35-BTST	30	176	2	III 400 V	3	254	219	3	254	219	si	si
KBS-42-BTST	30	187	3	III 400 V	3	254	219	3	254	219	si	si

CÁMARAS FRIGORÍFICAS MONOBLOCKS



MOCHILA ALTA TEMPERATURA R-404 A

MODELO	PRECIO €
KBA-08-TNEM	2.003,45
KBA-11-TNEM	2.246,21
KBA-13-TNEM	2.443,62
KBA-17-TNEM	2.468,96
KBA-20-TNEM	3.331,96
KBA-25-TNEM	3.576,06
KBA-32-TNEM	3.882,84
KBA-35-TNEM	4.755,19
KBA-40-TNET	5.098,00

PORTES PAGADOS

prescripciones técnicas

• AISLAMIENTO	80 mm
• DENSIDAD DE CARGA	250 Kg/m ³
• MOVIMIENTO MERCANCÍA	10%
• T° MERCANCIA A LA ENTRADA	25°C
• CALOR ESPECÍFICO MERCANCÍA	0,90 Wat/Kg °C
• H. FUNCIONAMIENTO COMPRESOR	18 horas

MOCHILA BAJA TEMPERATURA R-404 A

MODELO	PRECIO €
KBA-10-BTEM	2.738,40
KBA-13-BTEM	2.798,42
KBA-18-BTEM	4.002,89
KBA-27-BTEM	4.361,70
KBA-31-BTET	6.546,55
KBA-34-BTET	6.711,96

PORTES PAGADOS

prescripciones técnicas

• AISLAMIENTO	100 mm
• DENSIDAD DE CARGA	250 Kg/m ³
• MOVIMIENTO MERCANCÍA	10%
• T° MERCANCIA A LA ENTRADA	-5°C
• CALOR ESPECÍFICO MERCANCÍA	0,51 Wat/Kg °C
• H. FUNCIONAMIENTO COMPRESOR	18 horas

TECHO ALTA TEMPERATURA R-404 A

MODELO	PRECIO €
KBS-08-TNEM	2.444,95
KBS-11-TNEM	2.476,97
KBS-13-TNEM	2.627,69
KBS-17-TNEM	2.829,10
KBS-20-TNEM	3.801,49
KBS-25-TNEM	4.033,57
KBS-32-TNEM	4.695,16
KBS-35-TNET	5.783,59
KBS-40-TNET	6.390,49

PORTES PAGADOS

Los equipos incluyen:

- COMPRESOR HERMÉTICO
- EVAPORADOR VENTILADO
- CONTROL ELECTRÓNICO
- DESESCARCHE POR GAS CALIENTE
- EVAPORACIÓN DE AGUA AUTOMÁTICA
- LUZ INTERIOR CÁMARA
- MANUAL DEL USUARIO

TECHO BAJA TEMPERATURA R-404 A

MODELO	PRECIO €
KBS-07-BTEM	2.934,48
KBS-10-BTEM	2.978,49
KBS-13-BTEM	3.331,96
KBS-18-BTET	4.612,47
KBS-27-BTET	4.979,27
KBS-30-BTST	6.218,43
KBS-35-BTST	6.994,73
KBS-42-BTST	7.719,01

PORTES PAGADOS

Los equipos incluyen:

- COMPRESOR HERMÉTICO -E- Y SEMIHERMÉTICO -S-
- EVAPORADOR VENTILADO
- CONTROL ELECTRÓNICO
- DESESCARCHE POR GAS CALIENTE
- EVAPORACIÓN DE AGUA AUTOMÁTICA
- LUZ INTERIOR CÁMARA
- MANUAL DEL USUARIO



ESTANTERÍAS LINEALES EN ALUMINIO Y POLIPROPILENO





ESTANTERÍAS: ACCESORIOS

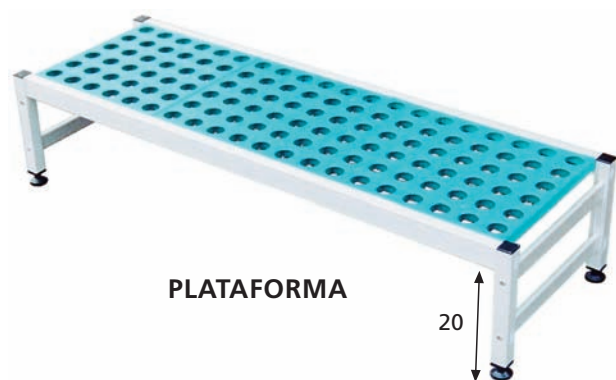

PLATAFORMA

20

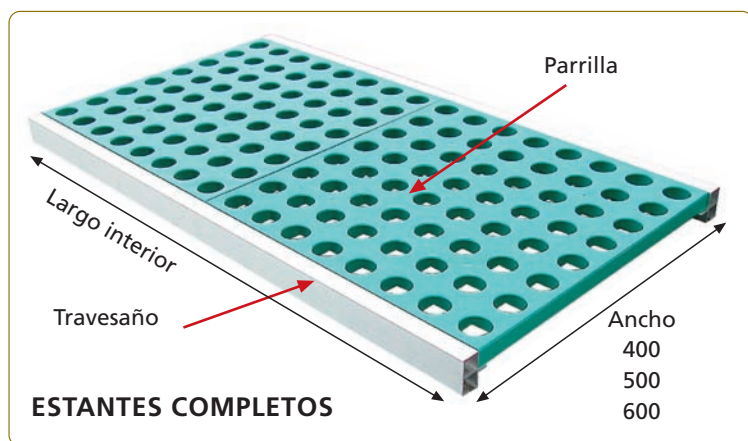

ESTANTES COMPLETOS

MONTAJE EN ÁNGULO

Práctico sistema. Las estanterías montadas en esquinas quedan diáfanas, sin mermar la resistencia del conjunto.



MONTAJE SIN HERRAMIENTAS

La brida metálica encaja en los postes de las escalerillas y soportan los travesaños.



RUEDAS EN OPCIÓN

Con o sin freno; para desplazar la estantería en caso de necesidad.



NIVELADOR

Con paso de rosca interior cumpliendo las normas sanitarias.

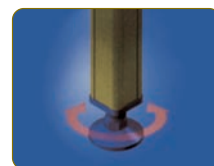

ESTANTES FONDO 400, 500 Y 600 mm

	A	B	C	D	E	F	G	H	I
FONDO 400	37,90 €	42,15 €	46,33 €	52,52 €	56,72 €	61,18 €	65,99 €	72,18 €	76,07 €
FONDO 500	40,58 €	45,23 €	49,84 €	56,54 €	61,16 €	65,99 €	71,25 €	79,19 €	83,56 €
FONDO 600	46,58 €	51,68 €	56,03 €	65,49 €	70,55 €	75,85 €	81,49 €	90,91 €	95,68 €

(Con anclajes incluidos)

accesorios

DESCRIPCIÓN	PRECIO €
BARRAS DE COLGAR	
Para A, B y C	26,60
Para D, E y F	28,88
Para G, H e I	31,15
RUEDAS	
Sin freno	34,37
Con freno	39,03

ESCALERILLAS

MODELO	PRECIO €
FONDO 400	65,39
FONDO 500	65,88
FONDO 600	66,37
Para escalerillas de 2100 mm suplemento de: 26,83 €	
Montajes en ángulo	9,94
Anclaje de sujeción	1,25



ESTANTERÍAS CON ESTRUCTURA EN ALUMINIO Y PARRILLAS EN POLIPROPILENO



LONGITUD	FONDO 400			FONDO 500			FONDO 600		
	3 niv	4 niv	5 niv	3 niv	4 niv	5 niv	3 niv	4 niv	5 niv
744	243,77 €	281,41 €	319,07 €	252,82 €	293,17 €	333,51 €	273,44 €	320,03 €	366,61 €
856	256,53 €	298,43 €	340,34 €	266,82 €	311,83 €	356,83 €	288,76 €	340,44 €	392,13 €
968	269,13 €	315,23 €	361,33 €	280,65 €	330,27 €	379,89 €	301,76 €	357,78 €	413,81 €
1087	287,65 €	339,93 €	392,20 €	300,74 €	357,05 €	413,37 €	330,16 €	395,65 €	461,13 €
1199	300,25 €	356,72 €	413,20 €	314,57 €	375,49 €	436,42 €	345,32 €	415,86 €	486,40 €
1311	313,66 €	374,62 €	435,56 €	329,22 €	395,04 €	460,85 €	361,25 €	437,10 €	512,95 €
1423	328,07 €	393,82 €	459,58 €	344,87 €	415,89 €	486,91 €	378,18 €	459,67 €	541,17 €
1539	344,13 €	415,24 €	486,33 €	362,48 €	439,38 €	516,28 €	406,42 €	497,33 €	588,24 €
1651	357,72 €	433,35 €	508,97 €	377,31 €	459,14 €	540,98 €	420,73 €	516,41 €	612,09 €
1682	442,77 €	524,95 €	607,14 €	462,86 €	551,25 €	639,62 €	510,67 €	614,04 €	717,41 €
1794	455,36 €	541,75 €	628,13 €	476,69 €	569,69 €	662,68 €	523,67 €	631,38 €	739,09 €
1906	467,96 €	558,54 €	649,13 €	490,52 €	588,12 €	685,74 €	536,68 €	648,72 €	760,77 €
2025	486,48 €	583,24 €	680,00 €	510,60 €	614,91 €	719,22 €	565,07 €	686,58 €	808,09 €
2144	505,02 €	607,94 €	710,87 €	530,70 €	641,70 €	752,70 €	593,47 €	724,44 €	855,42 €
2256	517,61 €	624,73 €	731,87 €	544,53 €	660,14 €	775,75 €	608,63 €	744,66 €	880,69 €
2368	530,20 €	641,53 €	752,87 €	558,36 €	678,59 €	798,81 €	623,79 €	764,87 €	905,95 €
2480	543,62 €	659,42 €	775,23 €	573,02 €	698,12 €	823,23 €	639,72 €	786,11 €	932,50 €
2592	557,05 €	677,32 €	797,59 €	587,67 €	717,66 €	847,65 €	655,65 €	807,35 €	959,05 €
2704	571,45 €	696,52 €	821,61 €	603,32 €	738,52 €	873,72 €	672,58 €	829,92 €	987,27 €
2816	585,86 €	715,74 €	845,62 €	618,96 €	759,38 €	899,80 €	689,51 €	852,49 €	1.015,48 €
2932	601,91 €	737,14 €	872,38 €	636,58 €	782,87 €	929,15 €	717,75 €	890,15 €	1.062,55 €
3048	617,97 €	758,56 €	899,13 €	654,20 €	806,35 €	958,52 €	745,99 €	927,81 €	1.109,62 €
3160	631,56 €	776,67 €	921,77 €	669,02 €	826,11 €	983,22 €	760,30 €	946,89 €	1.133,48 €
3272	645,14 €	794,77 €	944,41 €	683,83 €	845,88 €	1.007,92 €	774,62 €	965,98 €	1.157,33 €
3313	734,97 €	892,76 €	1.050,54 €	774,48 €	944,79 €	1.115,08 €	871,94 €	1.073,45 €	1.274,97 €
3425	747,57 €	909,55 €	1.071,52 €	788,33 €	963,22 €	1.138,13 €	887,10 €	1.093,67 €	1.300,24 €
3537	760,16 €	926,35 €	1.092,52 €	802,16 €	981,67 €	1.161,19 €	902,26 €	1.113,88 €	1.325,50 €
3649	773,59 €	944,23 €	1.114,88 €	816,81 €	1.001,21 €	1.185,61 €	918,19 €	1.135,12 €	1.352,05 €
3761	787,00 €	962,13 €	1.137,26 €	831,46 €	1.020,75 €	1.210,04 €	934,12 €	1.156,36 €	1.378,60 €
3873	800,42 €	980,02 €	1.159,62 €	846,11 €	1.040,28 €	1.234,46 €	950,05 €	1.177,60 €	1.405,15 €
3985	814,84 €	999,24 €	1.183,64 €	861,76 €	1.061,14 €	1.260,53 €	966,98 €	1.200,17 €	1.433,37 €
4097	829,23 €	1.018,44 €	1.207,65 €	877,40 €	1.082,00 €	1.286,61 €	983,91 €	1.222,75 €	1.461,58 €
4209	843,65 €	1.037,66 €	1.231,67 €	893,05 €	1.102,86 €	1.312,67 €	1.000,84 €	1.245,32 €	1.489,80 €
4325	859,70 €	1.059,06 €	1.258,41 €	910,66 €	1.126,35 €	1.342,04 €	1.029,08 €	1.282,97 €	1.536,87 €
4441	875,76 €	1.080,46 €	1.285,18 €	928,28 €	1.149,84 €	1.371,40 €	1.057,32 €	1.320,63 €	1.583,94 €
4557	891,81 €	1.101,87 €	1.311,93 €	945,90 €	1.173,34 €	1.400,77 €	1.085,56 €	1.358,29 €	1.631,01 €
4669	905,40 €	1.119,99 €	1.334,57 €	960,72 €	1.193,10 €	1.425,46 €	1.099,88 €	1.377,37 €	1.654,87 €
4781	918,98 €	1.138,09 €	1.357,21 €	975,53 €	1.212,85 €	1.450,16 €	1.114,19 €	1.396,46 €	1.678,72 €
4893	932,57 €	1.156,21 €	1.379,85 €	990,36 €	1.232,61 €	1.474,86 €	1.128,50 €	1.415,54 €	1.702,58 €
4930	1.016,96 €	1.246,94 €	1.476,91 €	1.075,25 €	1.323,83 €	1.572,42 €	1.212,59 €	1.505,37 €	1.798,15 €

Para escalerillas de 2100 mm suplemento de: 26,83 €

